

SUBMITTAL DATA SHEET

Series Name: Electric Heater
Model Number: EAH-08E(UL)



Heater

Location: _____
 Engineer: _____
 Submitted to: _____
 Submitted by: _____
 Reference: _____

Approval: _____
 Date: _____
 Construction: _____
 Unit #: _____
 Drawing #: _____

SPECS

Code	22013201000044	
Model	EAH-08E(UL)	
Normal Operational		
Voltage	(V, Ph, Hz)	208 / 230, 1, 60
Current	A	28.8 / 32
Heat Power	kW	6 / 7.35
MCA	A	37 / 42
MAX. FUSE	A	40 / 45
Heater dimension	mm	535 x 258 x 204
	inch	21-1/8 x 10-1/8 x 8
Packaging dimension	mm	610 x 365 x 260
	inch	24 x 14-3/8 x 10-1/4
Net Weight	kg	3.3
	lbs	6.7
Gross Weight	kg	5.8
	lbs	12.8

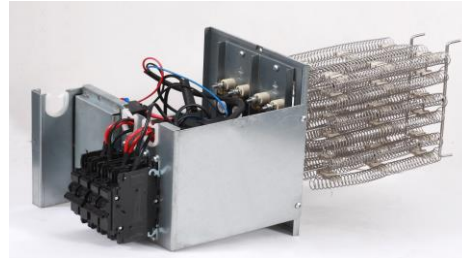

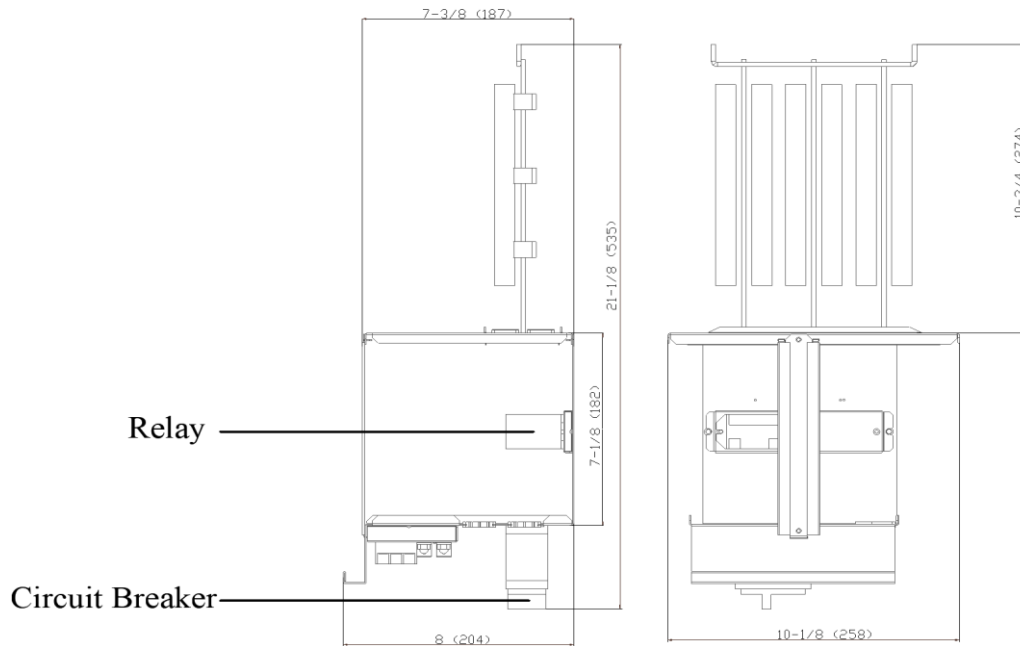

Heater dimension

unit: Inch (mm)



Wiring diagram

8KW/10KW HEAT KIT

-  : THERMAL LINK
-  : THERMAL CUT-OUT, SELF-RESETTING

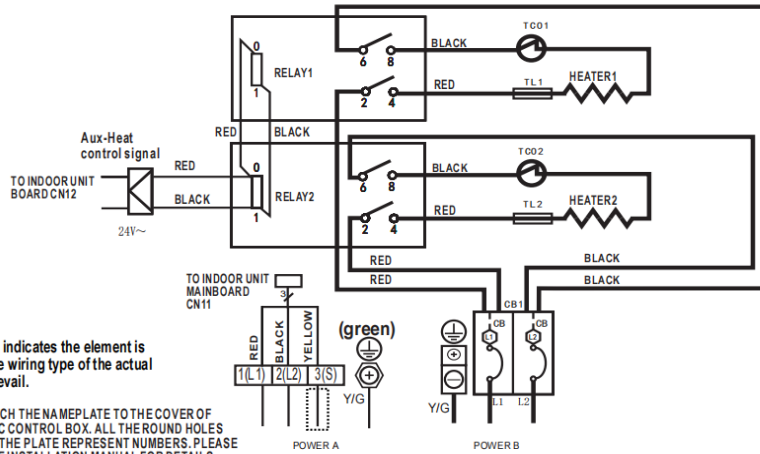







NOTE1:  This symbol indicates the element is optional. The wiring type of the actual unit shall prevail.

NOTE2: PLEASE ATTACH THE NAMEPLATE TO THE COVER OF THE ELECTRIC CONTROL BOX. ALL THE ROUND HOLES LOCATED ON THE PLATE REPRESENT NUMBERS. PLEASE REFER TO THE INSTALLATION MANUAL FOR DETAILS.

NOTE3: TO BE WIRED IN ACCORDANCE WITH NEC AND LOCAL CODES.

NOTE4: POWER A, B, C, D ARE DIFFERENT POWERS.

Electric heating is only applicable to 208-230V.

Round hole number	Relay number	Round hole number	Circuit breaker number
	RELAY 1		CB1
	RELAY2		
			
			
			

The wiring mode of power supply A shall be based on the type of original wiring terminal of AHU; for type A, S position must be connected to the outdoor S; for type B, S position shall not be connected. When using 115VAC, connect L1 and L2 (L2 is used as N).

