

SUBMITTAL DATA SHEET



Series Name: Electric Heater
Model Number: EAH-10E(UL)

Heater

Location: _____
 Engineer: _____
 Submitted to: _____
 Submitted by: _____
 Reference: _____

Approval: _____
 Date: _____
 Construction: _____
 Unit #: _____
 Drawing #: _____

SPECS

| | | |
|----------------------------|----------------|----------------------|
| Code | 22013201000041 | |
| Model | EAH-10E(UL) | |
| Normal Operational | | |
| Voltage | (V, Ph, Hz) | 208 / 230, 1, 60 |
| Current | A | 36.1 / 40 |
| Heat Power | kW | 7.5 / 9.2 |
| MCA | A | 46 / 53 |
| MAX. FUSE | A | 50 / 60 |
| | | |
| Heater dimension | mm | 535 x 258 x 204 |
| | inch | 21-1/8 x 10-1/8 x 8 |
| Packaging dimension | mm | 610 x 365 x 260 |
| | inch | 24 x 14-3/8 x 10-1/4 |
| | | |
| Net Weight | kg | 3.1 |
| | lbs | 6.3 |
| Gross Weight | kg | 5.7 |
| | lbs | 12.6 |

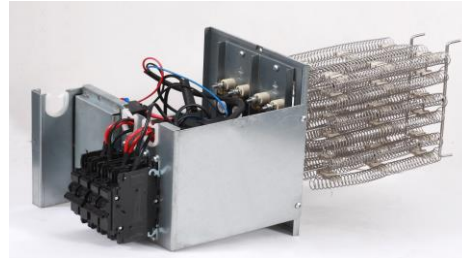

Heater dimension

unit: Inch (mm)

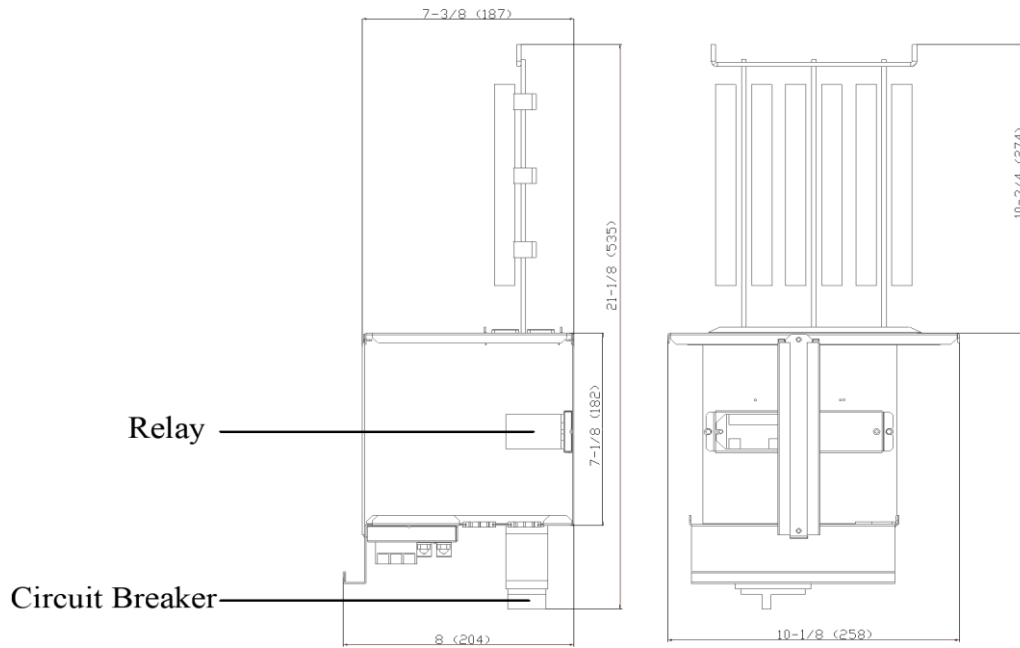



Wiring diagram

8KW/10KW HEAT KIT

 : THERMAL LINK

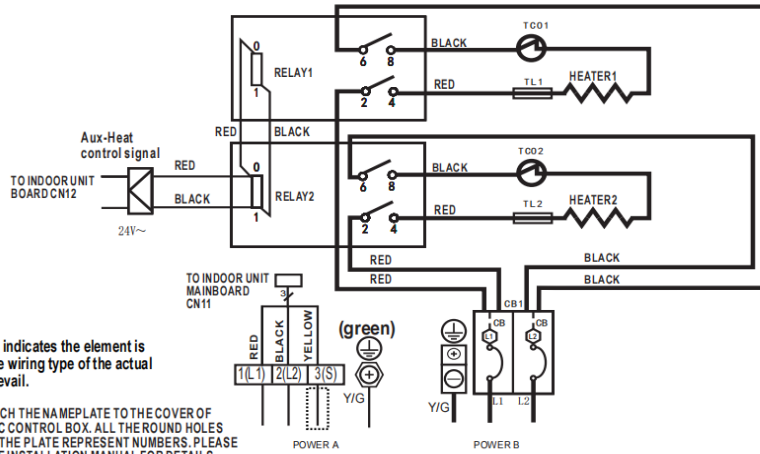
 : THERMAL CUT-OUT, SELF-RESETTING







NOTE1:  This symbol indicates the element is optional. The wiring type of the actual unit shall prevail.

NOTE2: PLEASE ATTACH THE NAMEPLATE TO THE COVER OF THE ELECTRIC CONTROL BOX. ALL THE ROUND HOLES LOCATED ON THE PLATE REPRESENT NUMBERS. PLEASE REFER TO THE INSTALLATION MANUAL FOR DETAILS.

NOTE3: TO BE WIRED IN ACCORDANCE WITH NEC AND LOCAL CODES.

NOTE4: POWER A, B, C, D ARE DIFFERENT POWERS.

Electric heating is only applicable to 208-230V.

| Round hole number | Relay number | Round hole number | Circuit breaker number |
|---|--------------|---|------------------------|
|  | RELAY 1 |  | CB1 |
|  | RELAY2 | | |
|  | | | |
|  | | | |

The wiring mode of power supply A shall be based on the type of original wiring terminal of AHU; for type A, S position must be connected to the outdoor S; for type B, S position shall not be connected. When using 115VAC, connect L1 and L2 (L2 is used as N).

